

Varenummer: 2301044213
 Beskrivelse: E+G Håndsving
 MT.80-AT

Mål

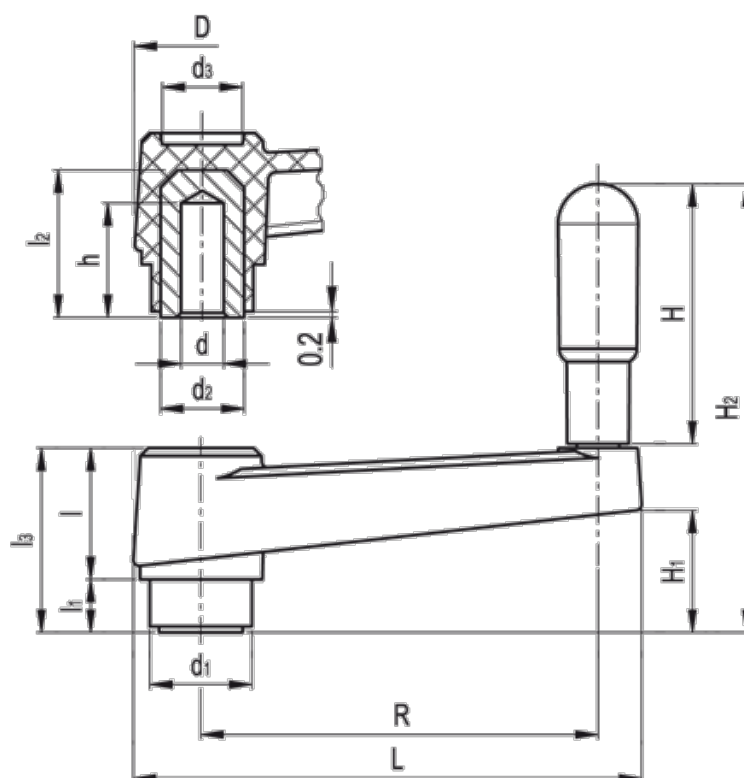

D	= 30	H2	= 98
d1	= 23.5	l	= 26
d2	= 18	L	= 105
d3	= 17	l1	= 10
d H7	= 10	l2	= 31
H	= 60	l3	= 36
h	= 25	R	= 80
H1	= 23.0	Vægt (g)	= 95